



DESSMANN
FINGERPRINT LOCK

DESSMANN - FINGERPRINT LOCK

User Guide V600 - V610 - S700
Version 1.5

Contents

1	Introduction	3
1.1	Packing List	3
1.2	Technical Data	4
2	Product Description	5
3	Basic Instructions	6
3.1	Batteries Setup	6
3.2	System Start and Shutdown	6
3.2.1	Start	6
3.2.2	Shutdown	6
4	Quick Start	7
4.1	Open the Door	8
4.1.1	with Finger	8
4.1.2	with Password	8
4.2	Close the Lock	8
5	Lock Menu	9
5.1	Enter the System Menu	9
5.2	Settings	9
5.2.1	Unlock Mode	9
5.2.2	Set Password	10
5.2.3	Set Time	10
5.3	Fingerprint Management	11
5.3.1	Add Fingerprint	11
5.3.2	Delete User	12
5.4	Information	13
5.4.1	Users Log	13
5.4.2	Users List	13
5.4.3	Storage	13
6	Lock Functions	14
6.1	Alarm Functions	14
6.1.1	Illegal Intrusion Alarm	14
6.1.2	Multi-attempts Alarm	14
6.1.3	Unlocked Door Alarm	14
6.2	Batteries Low	15
6.3	Emergency Battery	15
6.4	Locker Function	16
6.4.1	Close Position	16
6.4.2	Open Position	16
6.5	Mechanical Key	16
6.6	Factory Reset	17
7	Product Warranty	18
8	Contact Us	19

Chapter 1

Introduction

1.1 Packing List

Thank you for choosing a DESSMANN lock.

The following accessories are provided in order to set up and use your smart lock:

Item	Qty	Item	Qty
01/ Lock Front Panel	1 Pce	06/ Lock Accessories	1 Set
02/ Lock Back Panel	1 Pce	07/ 1.5V Batteries	4 Pces
03/ Lock	1 Pce	08/ Reset Stick	1 Pce
04/ Mechanical Key	3 Pces	09/ Rubber Seal	2 Pces
05/ User Guide	1 Book		

Please check all of the above accessories are included in the box before installation.

In case any of these items is damaged or missing, please contact us or your closest dealer.

Make sure that the mechanical keys can operate the lock.

1.2 Technical Data

Lock		
V600 & V610	Front Panel (HxLxW)	303x70x30mm
	Back Panel (HxLxW)	303x70x25mm
S700	Front Panel (HxLxW)	323x70x34mm
	Back Panel (HxLxW)	323x70x28mm
Lock	Weather Resistant Body	•
	Locker Mechanism	•
	Hidden Mechanical Lock	•
	Power Supply	2 sets of 4 AA Batteries
	Emergency Power Supply	9V Battery
	Durability	Lock Tested More Than 100,000 openings
Interface	Screen	Dot-Matrix Screen
	Keypad	15 Buttons
Functions	Main Opening Method	Fingerprint
	Alternative Opening Method	Password, Mechanical Key
	Fingerprint Capacity	80 Fingerprints
	Password Capacity	1 Password
	Time Display	•
	Low Power Notification	•
	System Reset Button	•
Security	Admin Authentication	Admin Fingerprint
	Admin Numbers	10 Admins
	Registered User Identification	By Name
	Users Log-In Record	1,024 entries
	Failed Fingerprint Authentication	System Freeze for 3 Minutes after 10 Failed Attempts
	Failed Password Authentication	System Freeze for 3 Minutes after 5 Failed Attempts
	Save Data when System is Down	•
	Wrapped Password	•

Due to continuous improvements, we reserve the right to amend any aspect of the above specifications without notice.

Chapter 2

Product Description

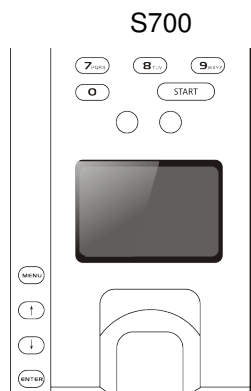
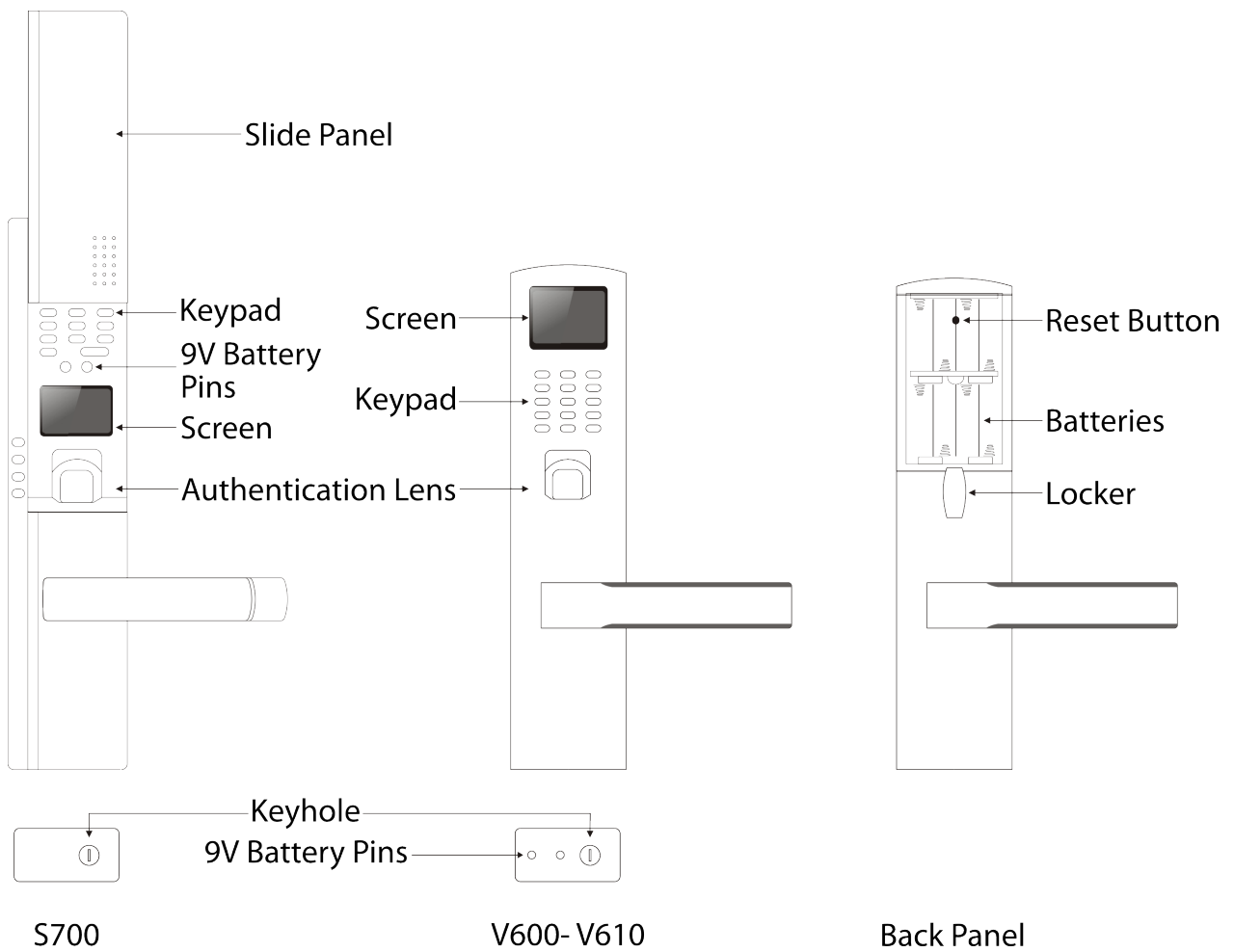

Numeric Keys:	Input Password and Name
START:	Start the system
MENU:	Enter the Menu or Go to Previous Menu
ENTER:	Save or Confirm
↑:	Scroll Up
↓:	Scroll Down

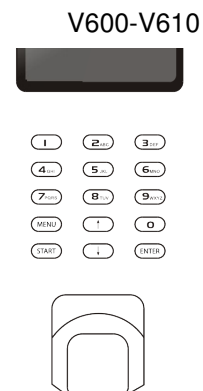

Chapter 3

Basic Instructions

3.1 Batteries Setup

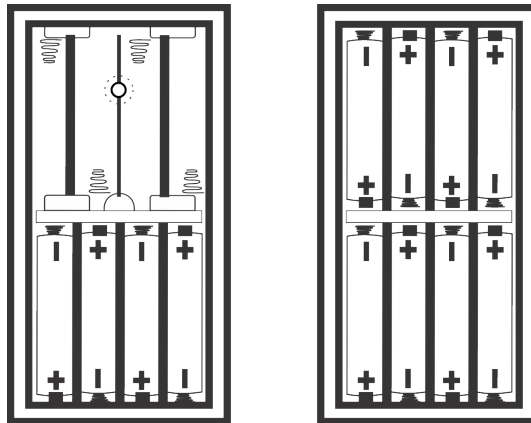

One set of 4 AA batteries or two sets of 4 AA batteries are required to power the lock.

3.2 System Start and Shutdown

3.2.1 Start

Make sure the batteries are properly installed, then start the system as follows:

- Scan your fingertip at the authentication lens

OR

- Press **ENTER**

The screen will lighten up after system start

3.2.2 Shutdown

System will automatically shutdown when not in use.

Chapter 4

Quick Start

Functions		Operation
Enter	System Menu	1/ Press START 2/ Press MENU Twice 3/ Enter Admin Fingerprint (Default: none)
New	Admin	1/ Enter System Menu 2/ Select "2.FP Management" 3/ Select "1.Add FP" 4/ Select "1.New Admin" 5/ Scan Fingertip Twice 6/ Enter a Name. ENTER to Save
	User	1/ Enter System Menu 2/ Select "2.FP Management" 3/ Select "1.Add FP" 4/ Select "2.New User" 5/ Scan Fingertip Twice 6/ Enter a Name. ENTER to save

4.1 Open the Door

4.1.1 with Finger

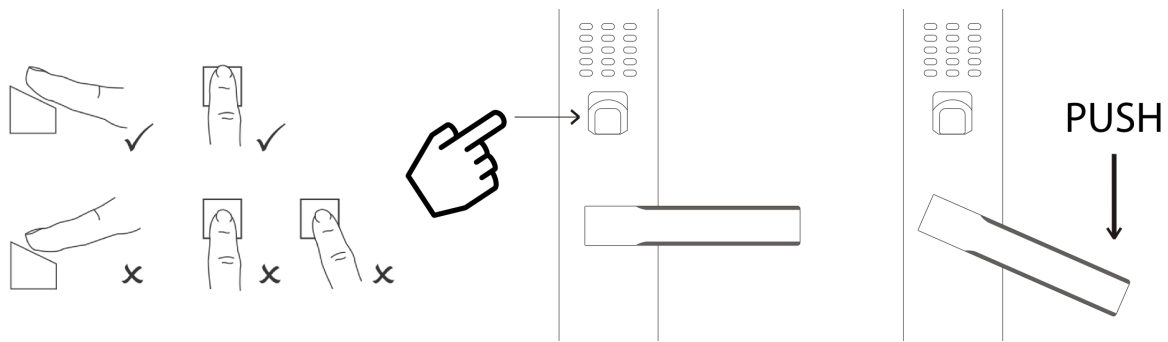

Scan your fingertip on the authentication lens. Push the handle.

Best Practices

To guarantee an optimal authentication:

- Make sure your finger is clean & dry
- Align your finger parallel to the authentication lens
- Do not move your finger for 2 seconds while scanning

4.1.2 with Password

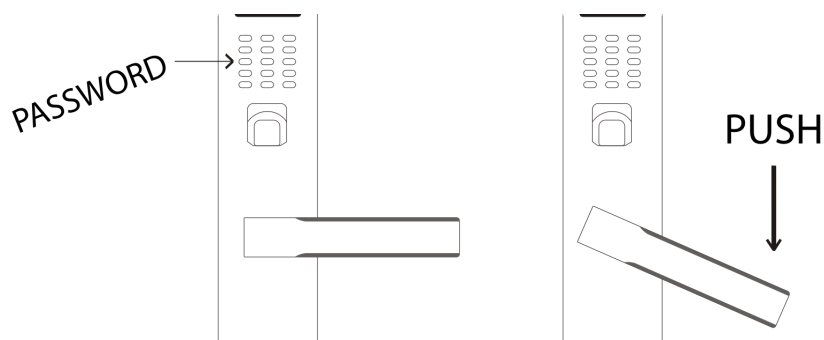

Enter password & press **ENTER** to unlock the door. Push the handle.

Smart Password

To confuse people looking at you when you type your password, it can be inputted within a random string of number. If your password is **888888**, the following combinations will still unlock the door:

- 1289888888
- 8888887556
- 8746388888451879

4.2 Close the Lock

The 3 locking bolts automatically close when you close the door.

Chapter 5

Lock Menu

DESSMANN lock management software let you easily manage your users. Browse with the arrows keys & press **ENTER** to confirm each step.

5.1 Enter the System Menu

System can only be managed with the admin fingerprint.
Start system (3.2.1) and press **MENU** twice:



Scan admin fingerprint (default: none).

5.2 Settings

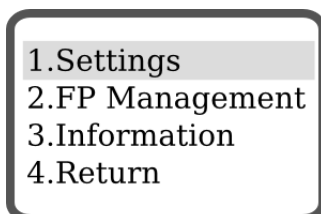

5.2.1 Unlock Mode

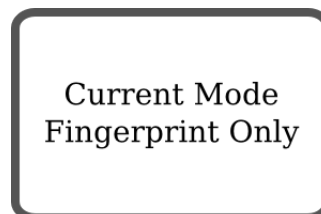
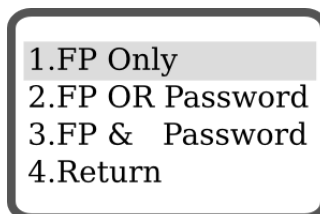
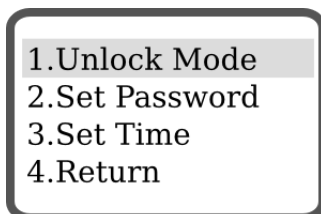

There are 3 modes offered by DESSMANN lock to open the door:

- **Fingerprint Only** - Identification with fingerprint only
- **Fingerprint OR Password** - Identification with either fingerprint OR password
- **Fingerprint AND Password** - Identification with fingerprint AND password

5.2.2 Set Password

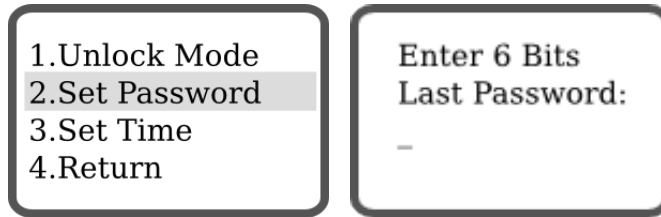

Enter the last password in use and press **ENTER**. (Default: 888888)

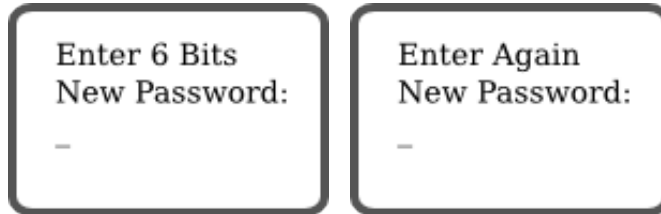

Enter the new password (must be 6 digits, no more, no less), press **ENTER**, confirm it again, press **ENTER**.

5.2.3 Set Time

We recommend you to properly set the time to fully enjoy all the functions of your lock.

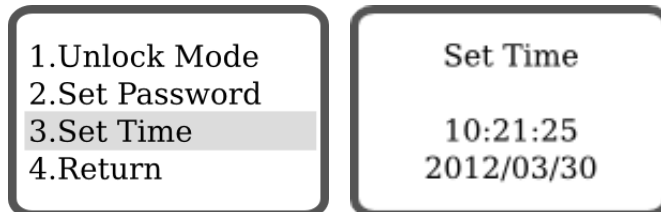

Change the values with the keypad. Press **ENTER** to confirm.

5.3 Fingerprint Management

1.Settings
 2.FP Management
 3.Information
 4.Return

5.3.1 Add Fingerprint

1.Add FP
 2.Delete FP
 3.Return

New Admin

1.New Admin
 2.New User
 3.Return

Scan Finger

Scan Again

Scan the new admin fingertip twice.

Enter Name:

^
 ↑ Clear ↓ Next

'name'
 Saved

Enter a name for this admin using the keypad. The name can only have a maximum of 6 digits or characters. Press **ENTER** to confirm.

Attention

Pay special attention to the following:

- The admins can manage the whole system, choose them carefully
- Up to 10 admins can be registered in the system
- Only a factory reset can delete admins from the system
- Use a distinctive finger for admin tasks & for everyday use

New User

1.New Admin 2.New User 3.Return	Scan Finger	Scan Again
---------------------------------------	-------------	------------

Scan the new user fingertip twice.

Enter Name: ^ ↑ Clear ↓ Next	'name' Saved
--------------------------------------	-----------------

Enter a name for this user using the keypad. The name can only have a maximum of 6 digits or characters. Press **ENTER** to confirm.

**Best Practices**

To ensure optimal results, register the same finger 2 to 3 times.

5.3.2 Delete User

1.Add FP 2.Delete FP 3.Return	1/2 1 Admin Steven 2 User Rachel 3 User Mark
-------------------------------------	---

Select the user you want to delete with the arrows keys & press **ENTER** to confirm.

Note: Admin cannot be deleted.

5.4 Information

- 1.Settings
- 2.FP Management
- 3.Information
- 4.Return

5.4.1 Users Log

- 1.Users Log
- 2.Users List
- 3.Storage
- 4.Return

Page Number	1/8	Opening Method
User Name	Steven F	Opening Time
	Mark F	
	P	
	09:50 2012-03-18	
	10:40 2012-03-19	
	17:15 2012-03-20	

Users log informs you about:

- User Name
- Opening Method
 - **F** for Fingerprint (Fingerprint Only Selected)
 - **R** for Fingerprint (Fingerprint OR Password Selected)
 - **P** for Password (Fingerprint OR Password Selected)
 - **A** for Fingerprint & Password
- Opening Time

Change page with the arrows keys & press **ENTER** to exit.

5.4.2 Users List

- 1.Users Log
- 2.Users List
- 3.Storage
- 4.Return

1/2
1 Admin Steven
2 User Rachel
3 User Mark

Users list informs you about registered user in the system. Change page with the arrows keys & press **ENTER** to exit.

5.4.3 Storage

- 1.Users Log
- 2.Users List
- 3.Storage
- 4.Return

In Use: 03
Available: 77

Storage informs you about how many users are registered in the system and how many new users can be enrolled. Press **ENTER** to exit.

- **In Use** - Total of fingerprint already allocated
- **Available** - Total of fingerprint available to register new users

Chapter 6

Lock Functions

6.1 Alarm Functions

6.1.1 Illegal Intrusion Alarm

If an illegal intrusion occurs, such as a thief trying to pick-lock your door, a buzzer will ring and the following will be displayed:

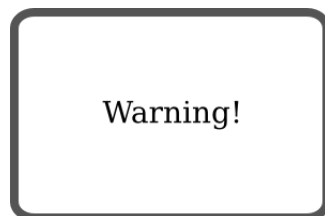

6.1.2 Multi-attempts Alarm

After 10 failed fingerprint authentications or 5 failed password authentications, the system will freeze for 3 minutes.



6.1.3 Unlocked Door Alarm

If the door is not properly closed, a buzzer will ring and the door will display the following for 60 seconds.

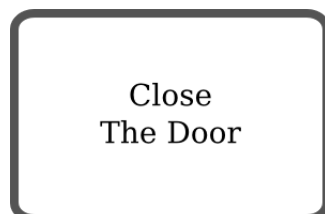

6.2 Batteries Low

Power Low
Change Batteries

- When the batteries are low, a buzzer will bip as a warning when you open the door & a message will be displayed on the screen at the same time.
- The lock will still operate for about 250 times after the first warning. To keep on operating your lock, replace the batteries as soon as possible.
- Check the system time after batteries replacement, because time information will be stored only 2 minutes without power.
- Recycle the used batteries according to the related laws and regulations of your country.

6.3 Emergency Battery

In case the lock runs out of battery. You can power the system with a 9V battery.

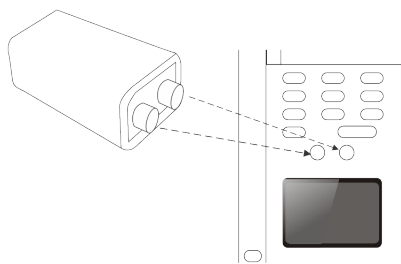

S700

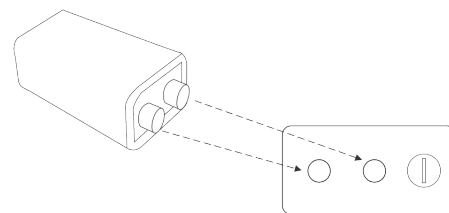

V600- V610

Just plug a 9V battery on the 2 9V battery pins and you can operate your lock as usual. Don't forget to change your batteries afterward.

6.4 Locker Function

6.4.1 Close Position

When the 3 locking bolts are out, turn the locker upwards. The lock will always be close. Nobody can open the door from outside (either with Fingerprint, Password or Mechanical Key).

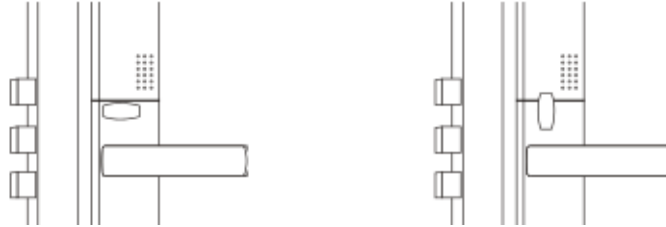

6.4.2 Open Position

When the 3 locking bolts are inside the lock, turn the locker upwards. The lock will always be open. The door can always be opened from the outside.

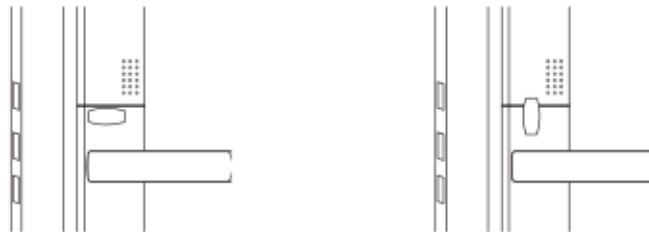

6.5 Mechanical Key

In case of system failure or damage, the lock can still be opened with a key. The keyhole is located at the bottom of the front panel.

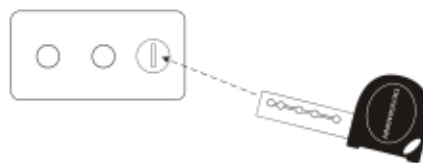

We advise you to leave the keys outside of your house, so you can get one of them in case of emergency.

6.6 Factory Reset

To delete all datas stored in the lock, proceed to a factory reset:

1. Open the battery cover, leave one set of 4 batteries and take one single battery out
2. Keep press **Reset Button** with the Reset Stick and re-install the battery

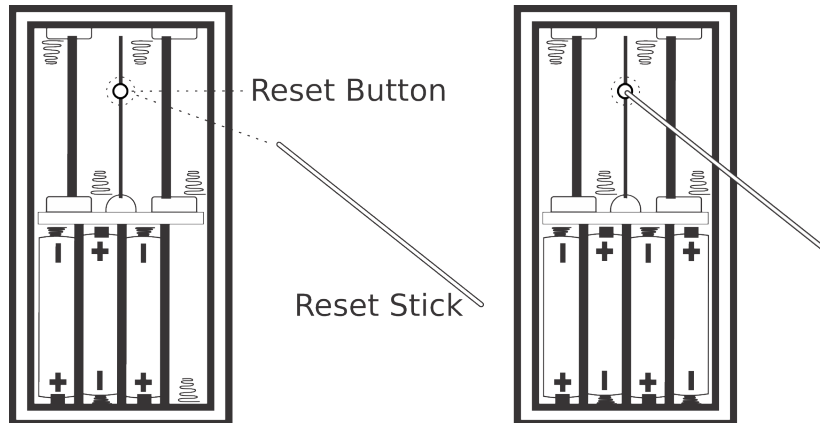

3. "Factory Reset?" will display on the screen, press **ENTER** or **START** to confirm. Factory settings are restored.



Attention

Factory reset will delete all the datas in the system:

- Admin Fingerprints
- User Fingerprints
- Password
- Log-in Record
- Time

Chapter 7

Product Warranty

DESSMANN warrants to the original purchaser that the hardware product shall be free from defects in material and workmanship for twelve (12) months from the date of purchase.

If a defect covered by this warranty occurs during this warranty period, DESSMANN or a DESSMANN AUTHORIZED REPAIR CENTER will repair the defective hardware product or component, free of charge. The original purchaser is entitled to this warranty only if the date of purchase is registered at point of sale or the consumer can demonstrate, to DESSMANN's satisfaction, that the product was purchased within the last 12 months.

SERVICE AFTER EXPIRATION OF WARRANTY

Please try our website at www.dessmannlock.com or call the Consumer Assistance Hotline at 0086-40060-00028 for troubleshooting information and/or referral to the nearest DESSMANN AUTHORIZED REPAIR CENTER. In some instances, it may be necessary for you to ship the complete product, FREIGHT PREPAID AND INSURED FOR LOSS OR DAMAGE, to the nearest service location. Please do not send any products to Dessmann without contacting us first.

WARRANTY LIMITATIONS

THIS WARRANTY SHALL NOT APPLY IF THIS PRODUCT:

1. IS MODIFIED OR TAMPERED WITH
2. IS DAMAGED BY NEGLIGENCE, ACCIDENT, UNREASONABLE USE, OR BY OTHER CAUSES UNRELATED TO DEFECTIVE MATERIALS OR WORKMANSHIP
3. HAS BEEN ASSEMBLED OR DISASSEMBLED, REPAIRED OR INSTALLED WITHOUT PERMISSION
4. HAS BEEN DAMAGED BY THE BATTERIES
5. AS HAD THE SERIAL NUMBER ALTERED, DEFACED OR REMOVED.

ANY APPLICABLE IMPLIED WARRANTIES, INCLUDING WARRANTIES OF MERCHANTABILITY AND FITNESS FOR A PARTICULAR PURPOSE, ARE HEREBY LIMITED IN DURATION TO THE WARRANTY PERIODS DESCRIBED ABOVE (12 MONTHS). IN NO EVENT SHALL DESSMANN BE LIABLE FOR CONSEQUENTIAL OR INCIDENTAL DAMAGES RESULTING FROM THE BREACH OF ANY IMPLIED OR EXPRESS WARRANTIES.

Chapter 8

Contact Us

Maintenance, Repair & Operations

Tel: +86 571 8711 9266

Fax: +86 571 8711 9299

Mail: mro@dessmannlock.com

www.dessmannlock.com